

CPQ quote: QUO0000011074 Rev: 2

Date & revision: 2024-10-30 rev.0

General exterior page 2
Curbside exterior page 3
Streetside exterior page 4
Front & rear exterior page 5
Curbside interior wall page 6
Streetside interior wall page 7
Front interior wall page 8
Rear interior wall page 9
Floor view page 10
Ceiling view page 11
Front console page 12
Rear consoles page 13
Floor console details page 14

DISCLAIMERS

Demers makes every effort to maintain the accuracy and quality of the information provided in these drawings. However, Demers cannot guarantee and assumes no legal liability or responsibility for the accuracy or completeness of the information provided. The information contained in these drawings is for general guidance only. You should always develop your quote and send to Demers for engineering validation to the feasibility of the custom options according to the specific configuration required by the customer.

Should there be any discrepancies between the CPQ configurator, the CPQ quote or sale sheet and these drawings; the CPQ configurator, the CPQ quote or sale sheet will take precedence. These drawings are subject to change by engineering during the construction process of the vehicle. Dimensional data for information only. The copyright of all content in these drawings is owned by Demers and/or the various manufacturers of our equipment. These drawings in part or whole cannot be changed, reproduced, stored in or transmitted onto any website or social media without the prior written consent from Demers.

MXPI70E - Dodge RAM 4500

Ebensburg Area Ambulance Association, PA

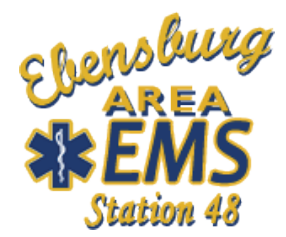

General exterior

Date: 2024-10-30 rev.0
Scale: 1:45
Draftman: TT

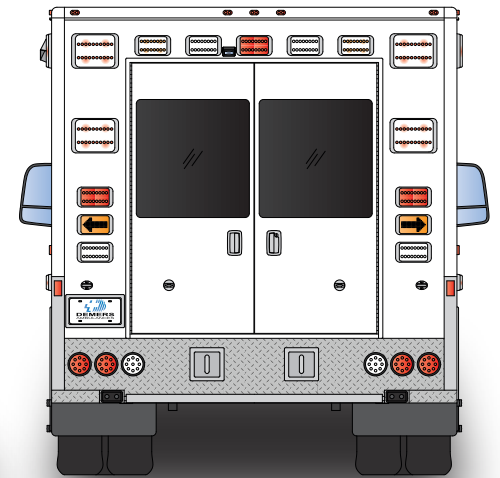

Curbside exterior

Date: 2024-10-30 rev.0
 Scale: 1:30
 Draftman: TT

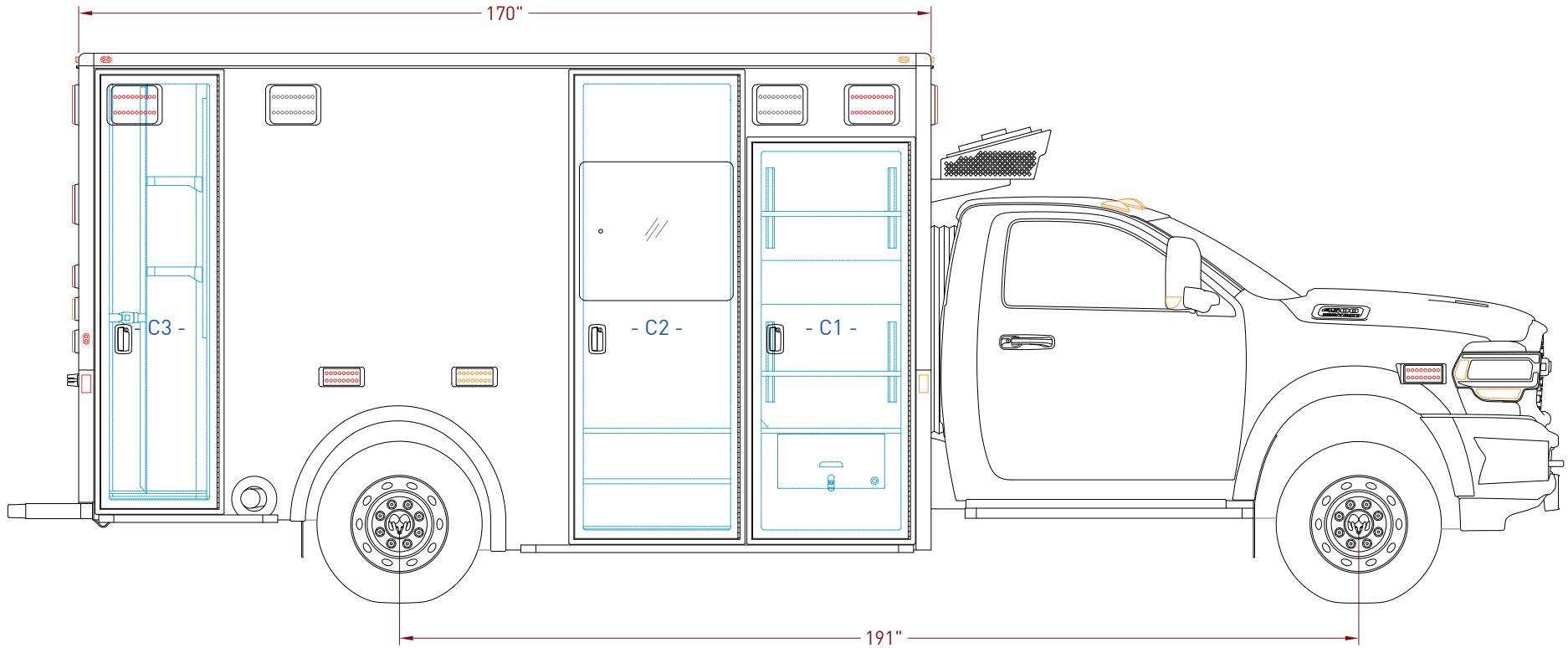

Compartment	Opening L x H	Interior dimensions L x H x D
C1	27.75" x 55.75"	30.25" x 57.25" x 32.00"
C2	29.25" x 88.75"	-
C3	20.00" x 82.75"	20.75" x 84.25" x 18.50"

Streetside exterior

Date: 2024-10-30 rev.0
Scale: 1:30
Draftman: TT

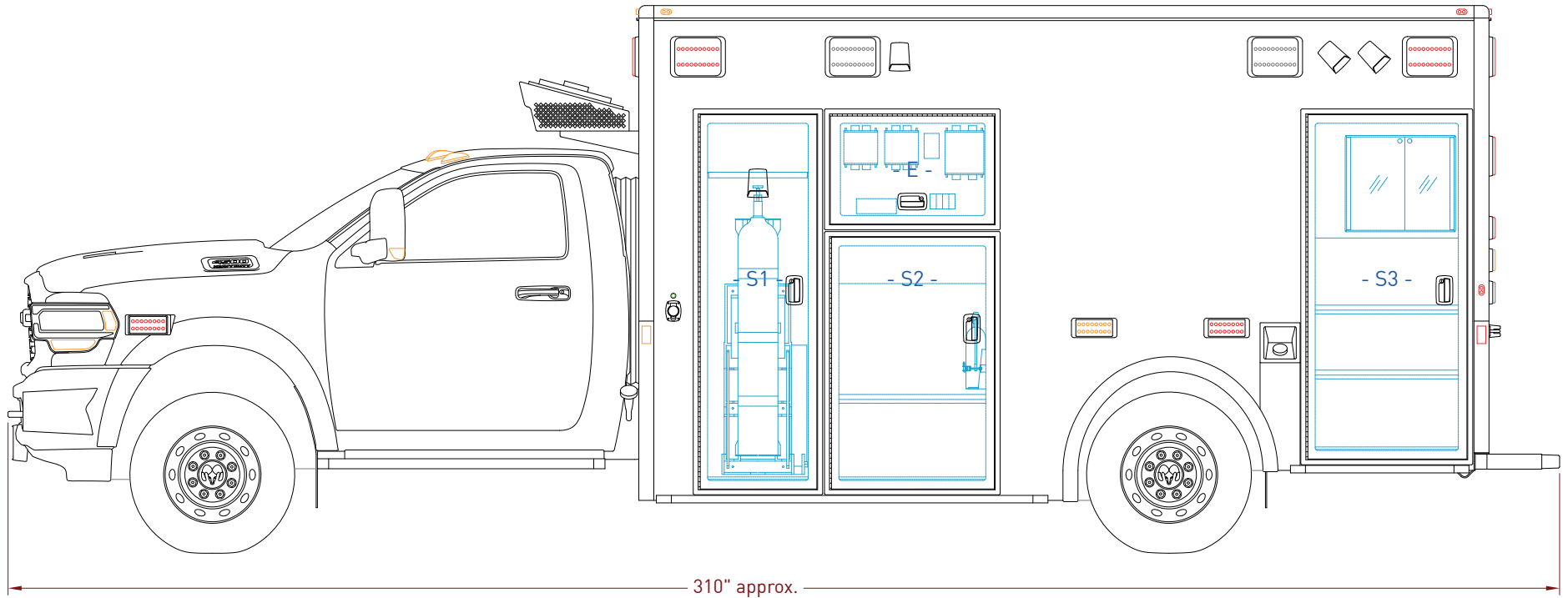

Compartment	Opening L x H	Interior dimensions L x H x D
S1	20.25" x 71.50"	23.75" x 79.50" x 18.00"
S2	29.25" x 47.00"	32.25" x 47.25" x 13.50"
S3 - Std height	28.50" x 65.50"	33.25" x 42.00" x 17.50"
E	29.25" x 18.50"	-

Front & rear exterior

Date: 2024-10-30 rev.0
 Scale: 1:30
 Draftman: TT

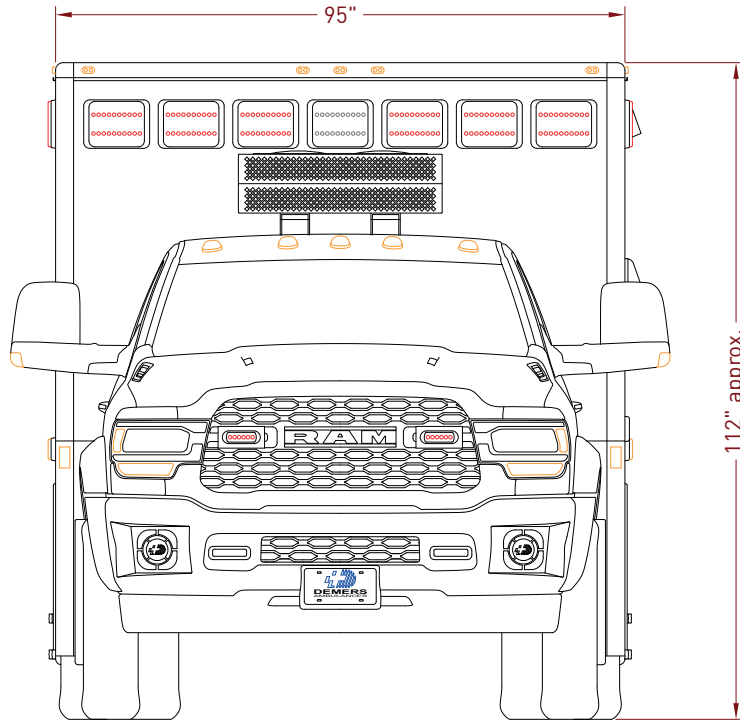

Note

The total height of the vehicle can be different according to chassis and suspensions

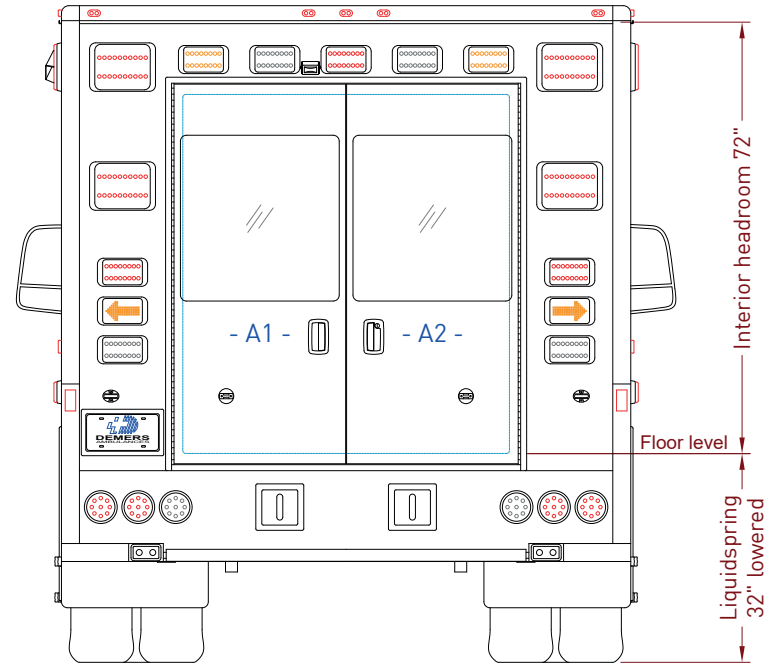

Note

The rear loading height of the vehicle can be different according to chassis and suspensions

Compartment	Opening L x H	Interior dimensions L x H x D
A1 & A2	54.50" x 59.75"	-

Curbside interior wall

Date: 2024-10-30 rev.0
 Scale: 1:20
 Draftman: TT

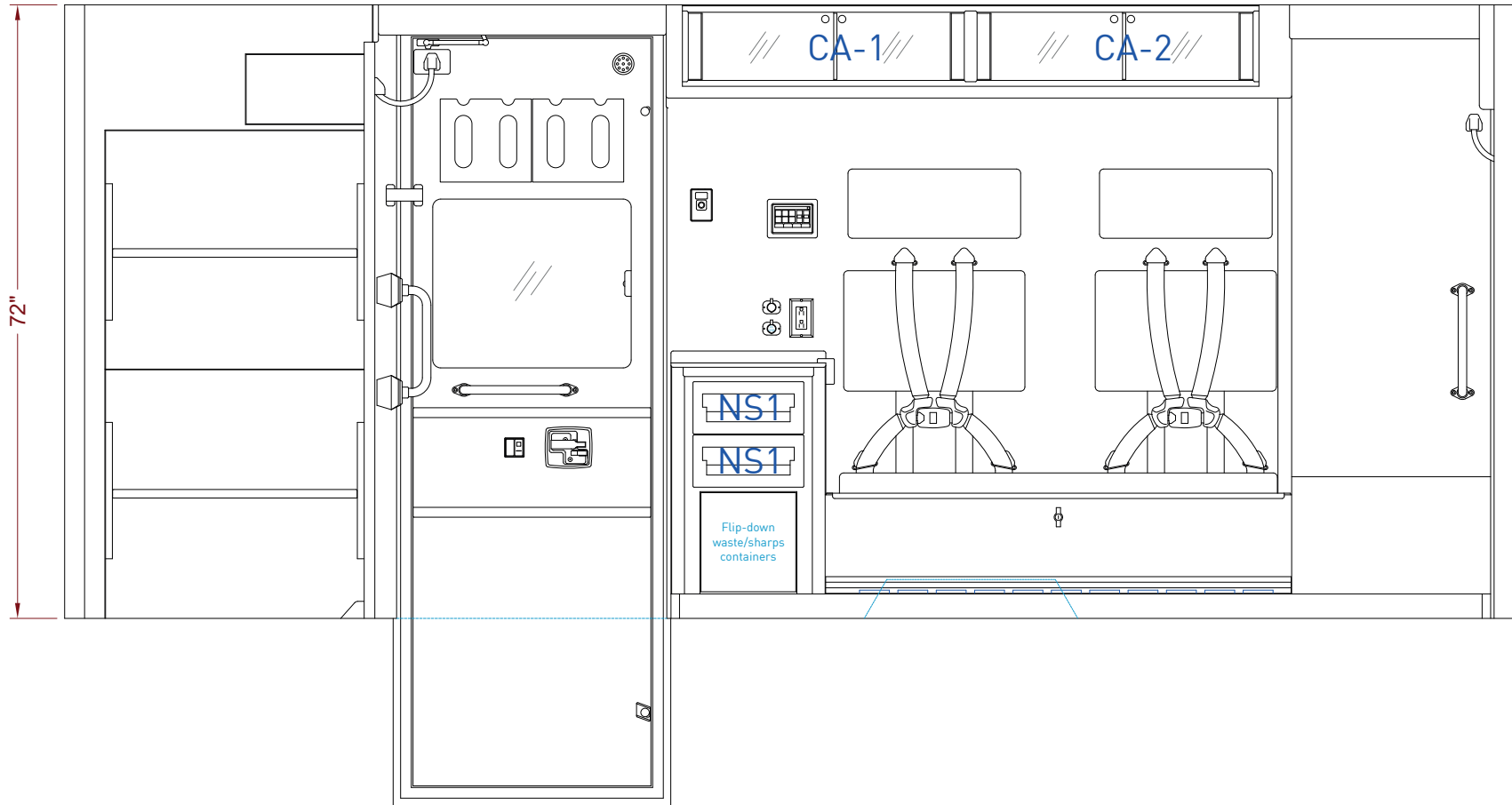

Compartment	Opening L x H	Interior dimensions L x H x D
Storage cabinet -CA-	32.25" x 8.00"	33.50" x 9.50" x 9.25"
Storage drawer -NS1-	-	10.75" x 4.75" x 18.00"

Streetside interior wall

Date: 2024-10-30 rev.0
 Scale: 1:20
 Draftman: TT

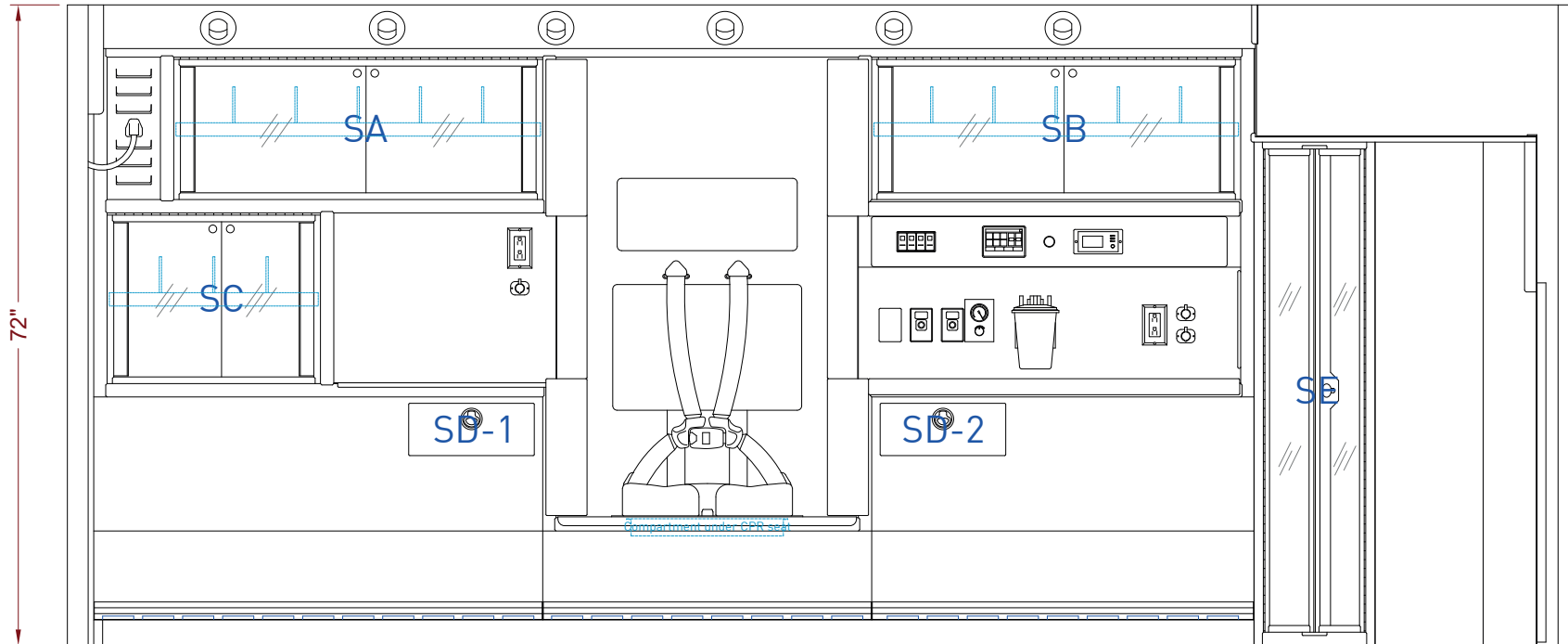

Compartment	Opening L x H	Interior dimensions L x H x D
Storage cabinet -SA-	41.50" x 16.00"	42.50" x 16.75" x 16.00"
Storage cabinet -SB-	41.50" x 16.00"	41.75" x 16.25" x 11.00"
Storage cabinet -SC-	24.00" x 19.25"	25.00" x 20.25" x 16.00"
Storage drawer -SD-	-	12.00" x 4.50" x 12.50"
Storage cabinet -SE-	16.50" x 54.25"	*25.50" x 57.25" x *15.75"

* This dimension is the maximum

Front interior wall

Date: 2024-10-30 rev.0
Scale: 1:20
Draftman: TT

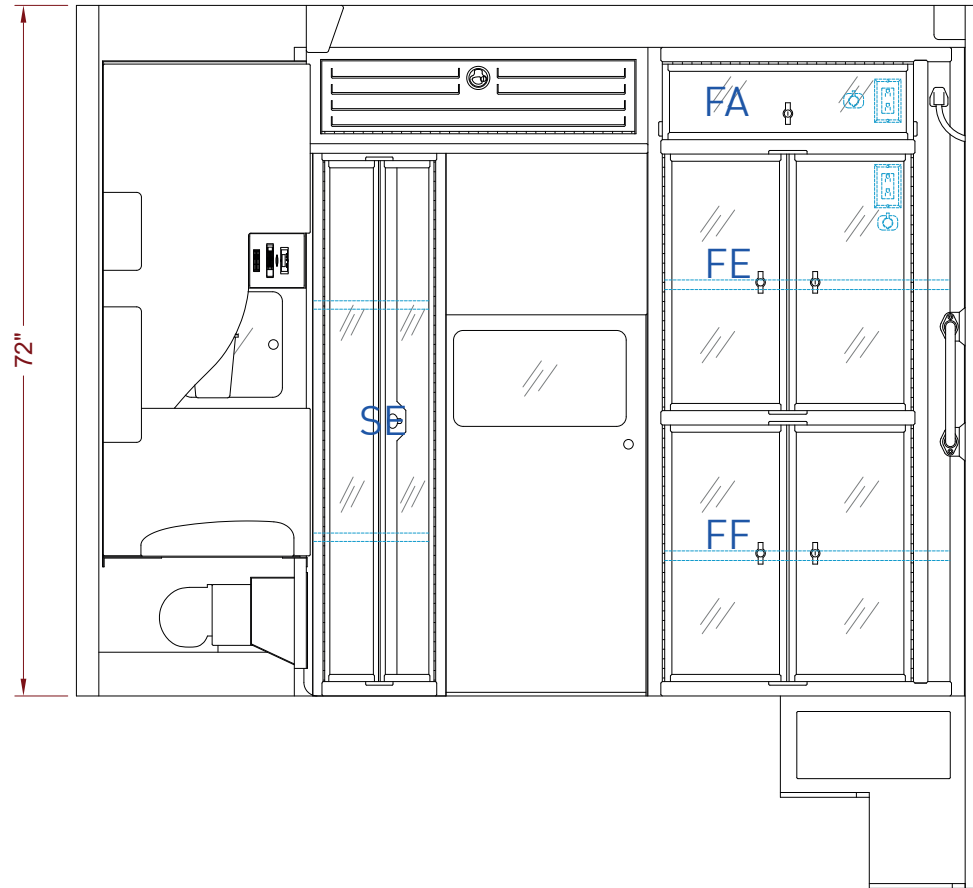

Compartment	Opening L x H	Interior dimensions L x H x D
Lockable comp. -FA-	26.00" x 8.00"	26.00" x 8.00" x 13.75"
High ALS comp. -FE-	26.00" x 26.75"	32.00" x 28.00" x 30.25"
Low ALS comp. -FF-	26.00" x 26.75"	32.00" x 29.25" x 30.25"

Rear interior wall

Date: 2024-10-30 rev.0
Scale: 1:20
Draftman: TT

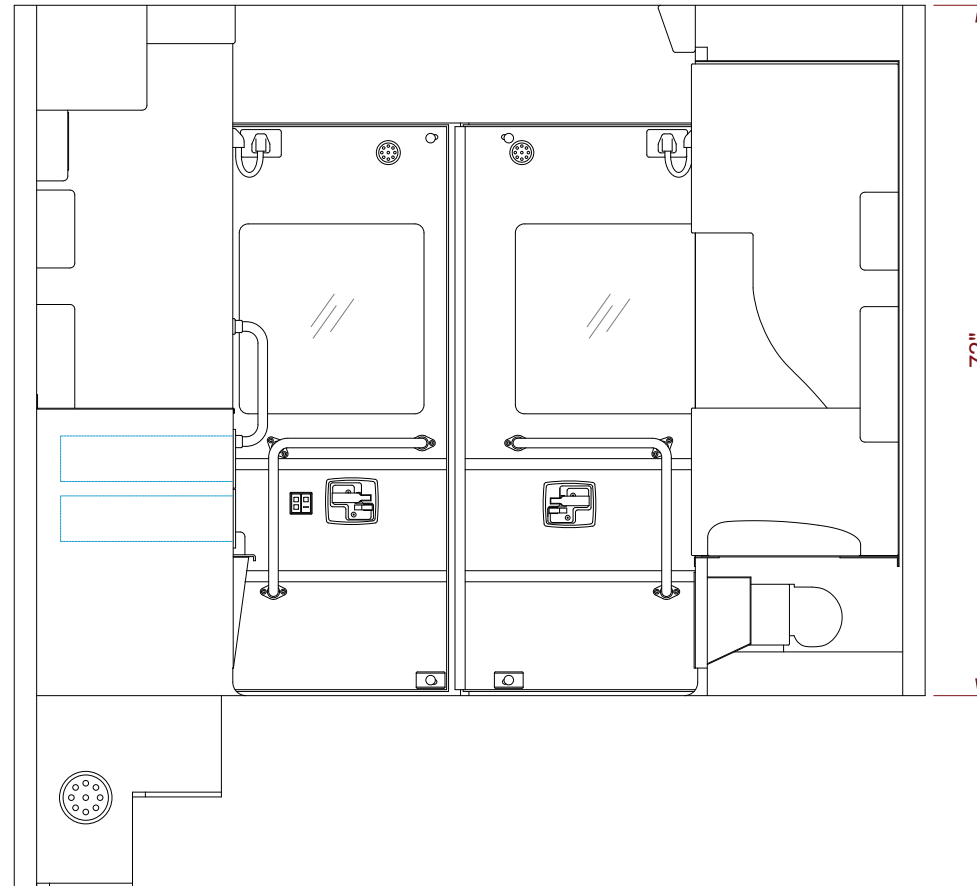

Floor view

Date: 2024-10-30 rev.0
Scale: 1:30
Draftman: TT

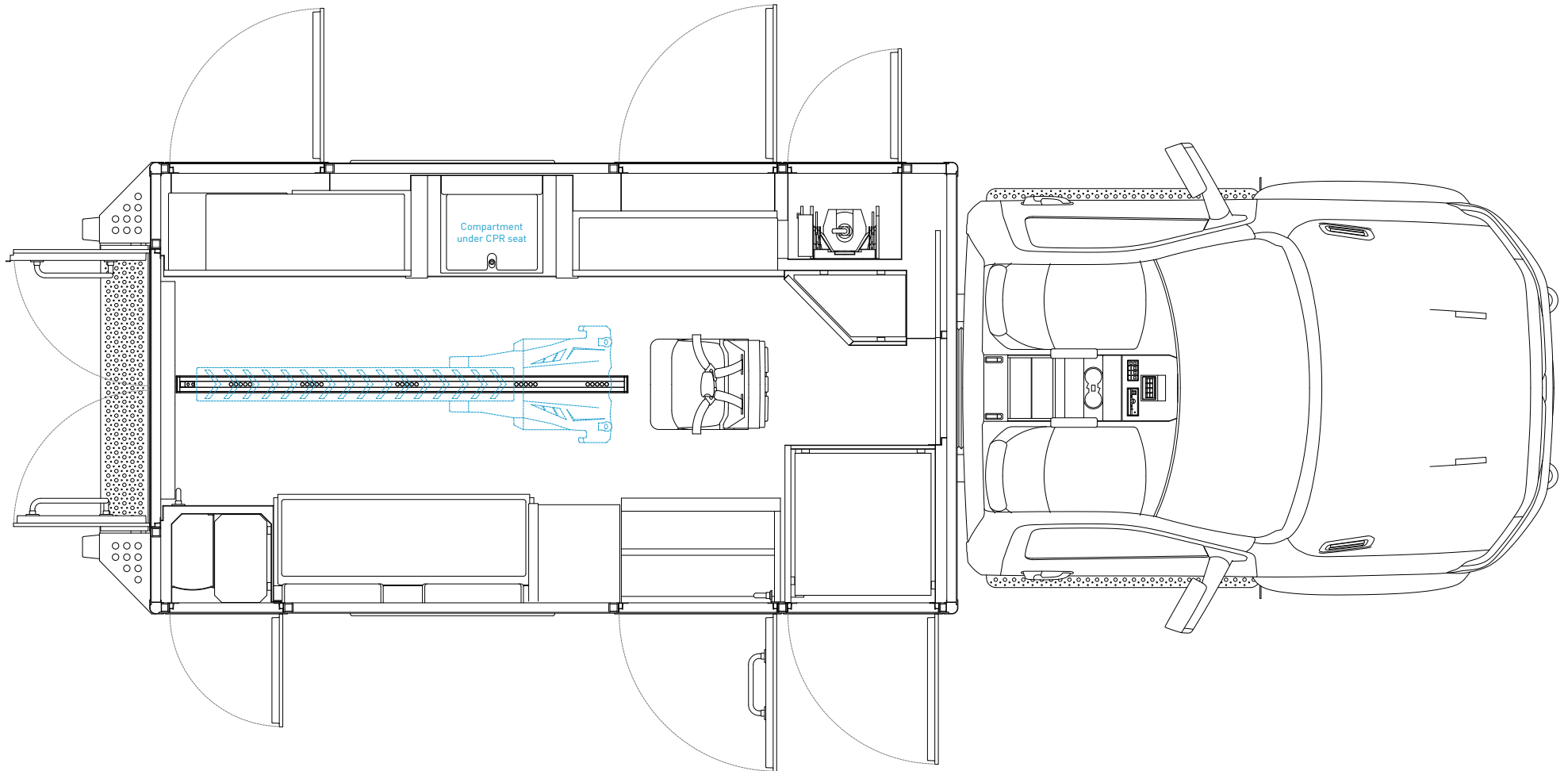

Ceiling view

Date: 2024-10-30 rev.0
Scale: 1:30
Draftman: TT

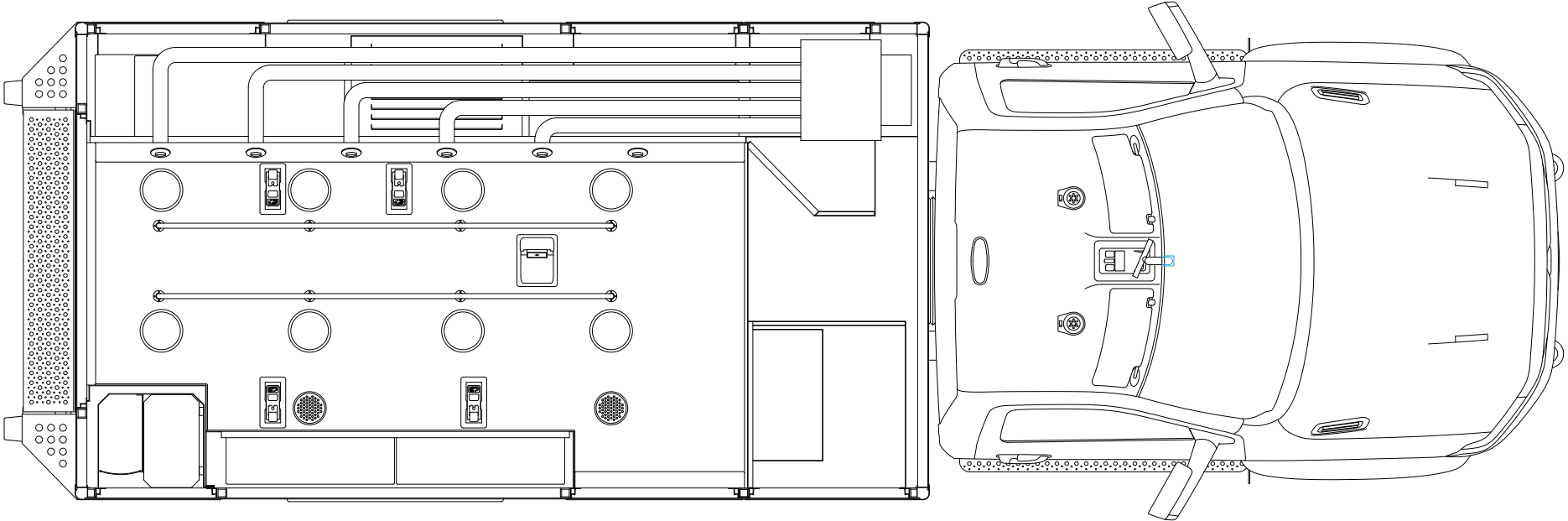

Front console

Date: 2024-10-30 rev.0
Scale: 1:3
Draftman: TT

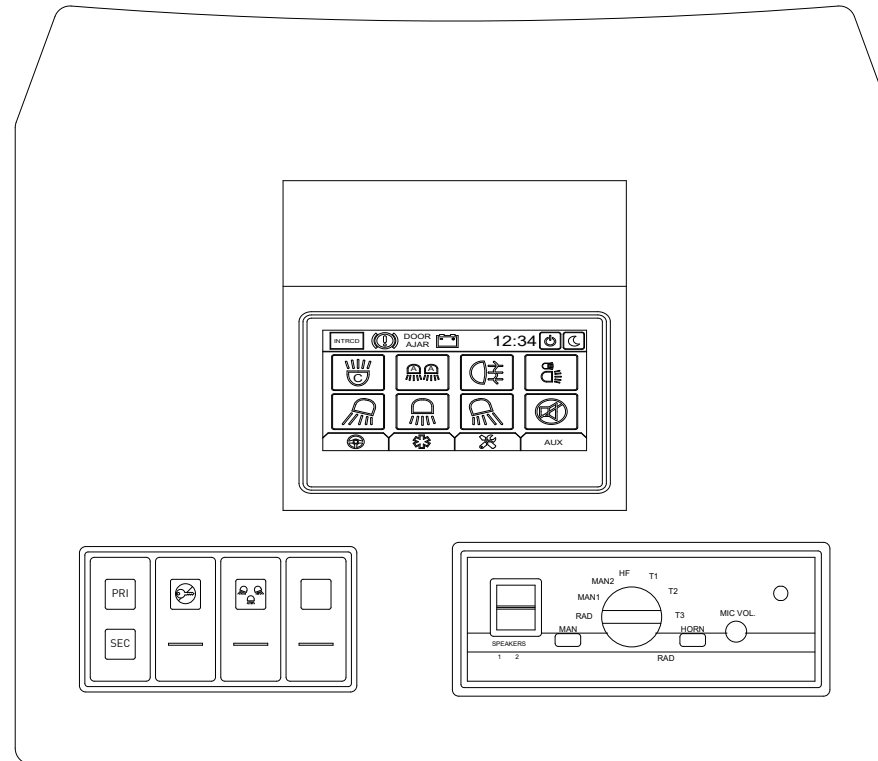

Streetside console

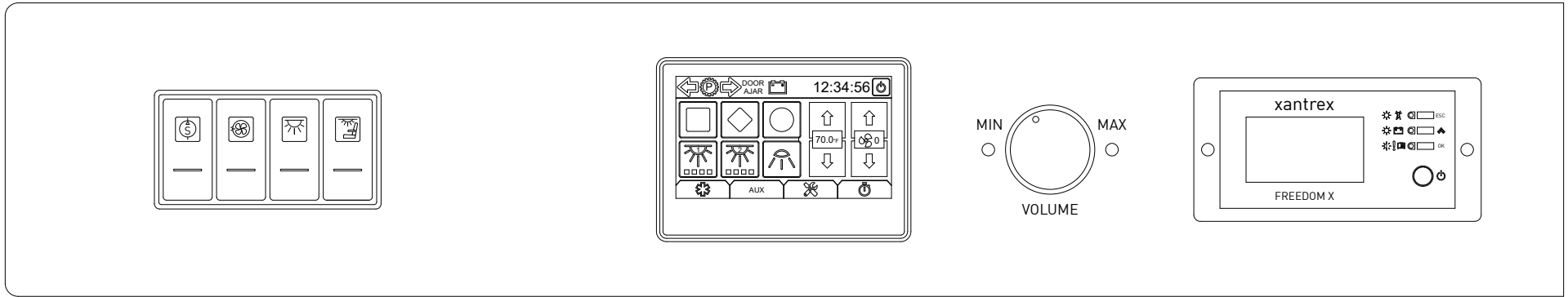

Curbside console

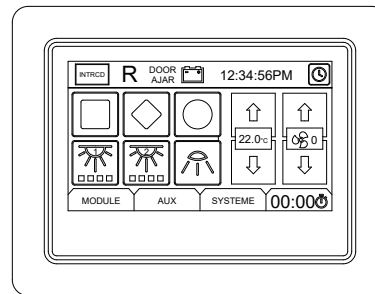

Floor console details

Date: 2024-10-30 rev.0
Scale: 1:7
Draftman: TT

Top view

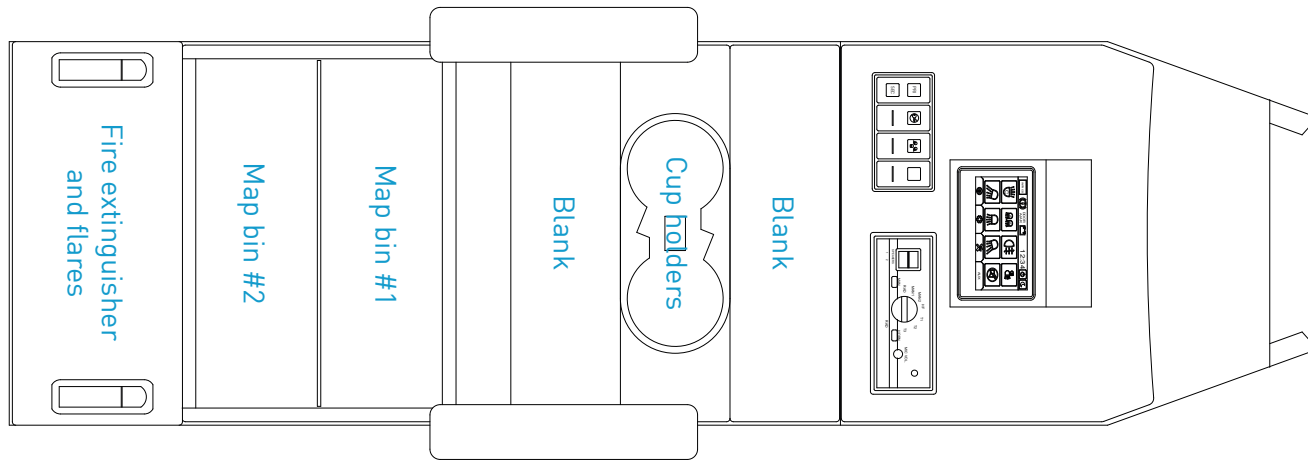

Side view

